



**GYPSY ROMA
TRAVELLER
HISTORY MONTH
COLOURING
BOOK**





**WE HOPE YOU ENJOY
OUR KIDS COLOURING
BOOK.**

**MADE BY LEEDS GATE
TO CELEBRATE
GYPSIES AND
TRAVELLERS**



Word search



APPLEBY
CHICKEN
HISTORY
WAGON

BOXING
DOG
HORSE

CAMP
FIRE
PICKUP

CART
HARNESS
TRAILER

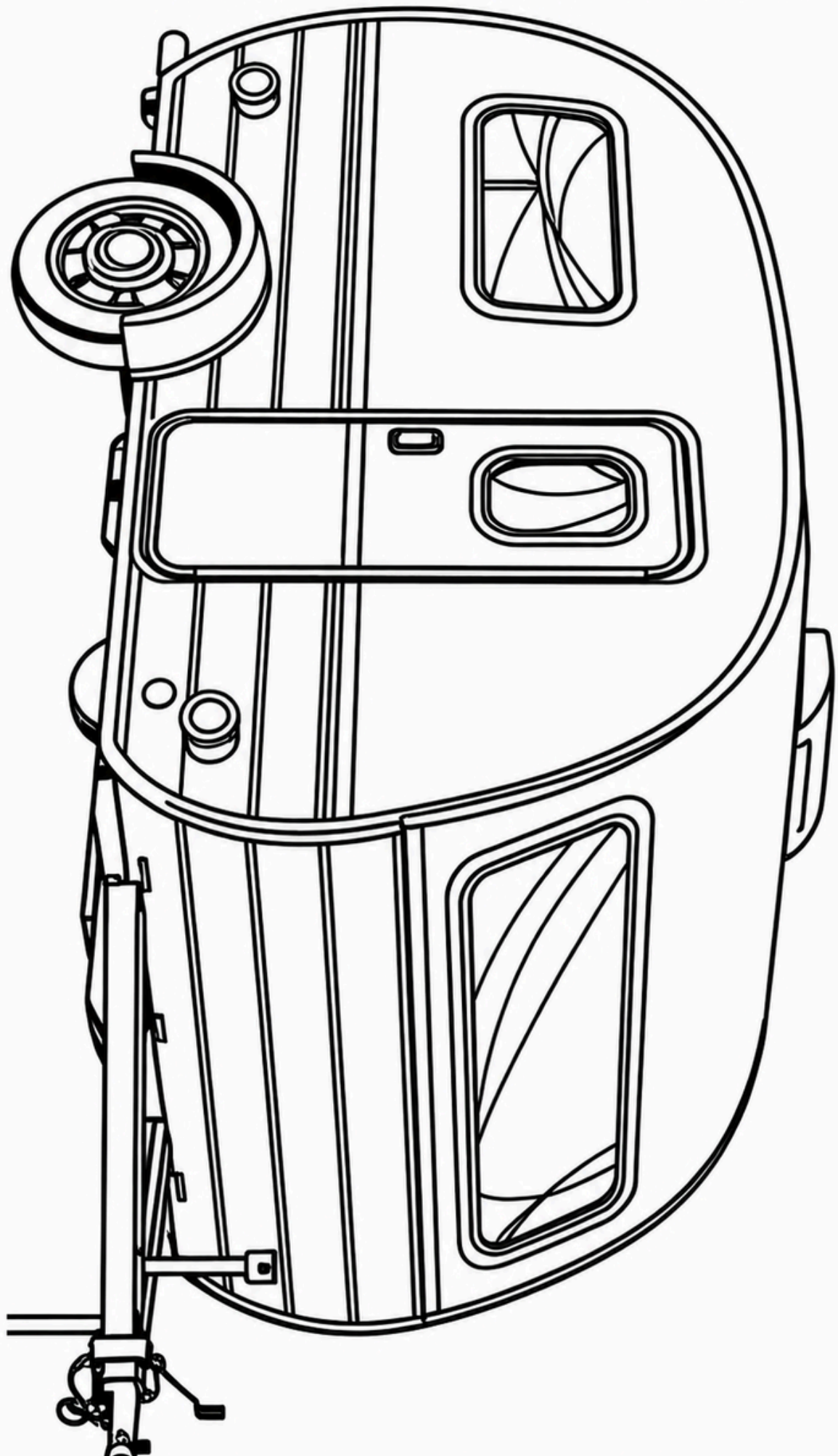



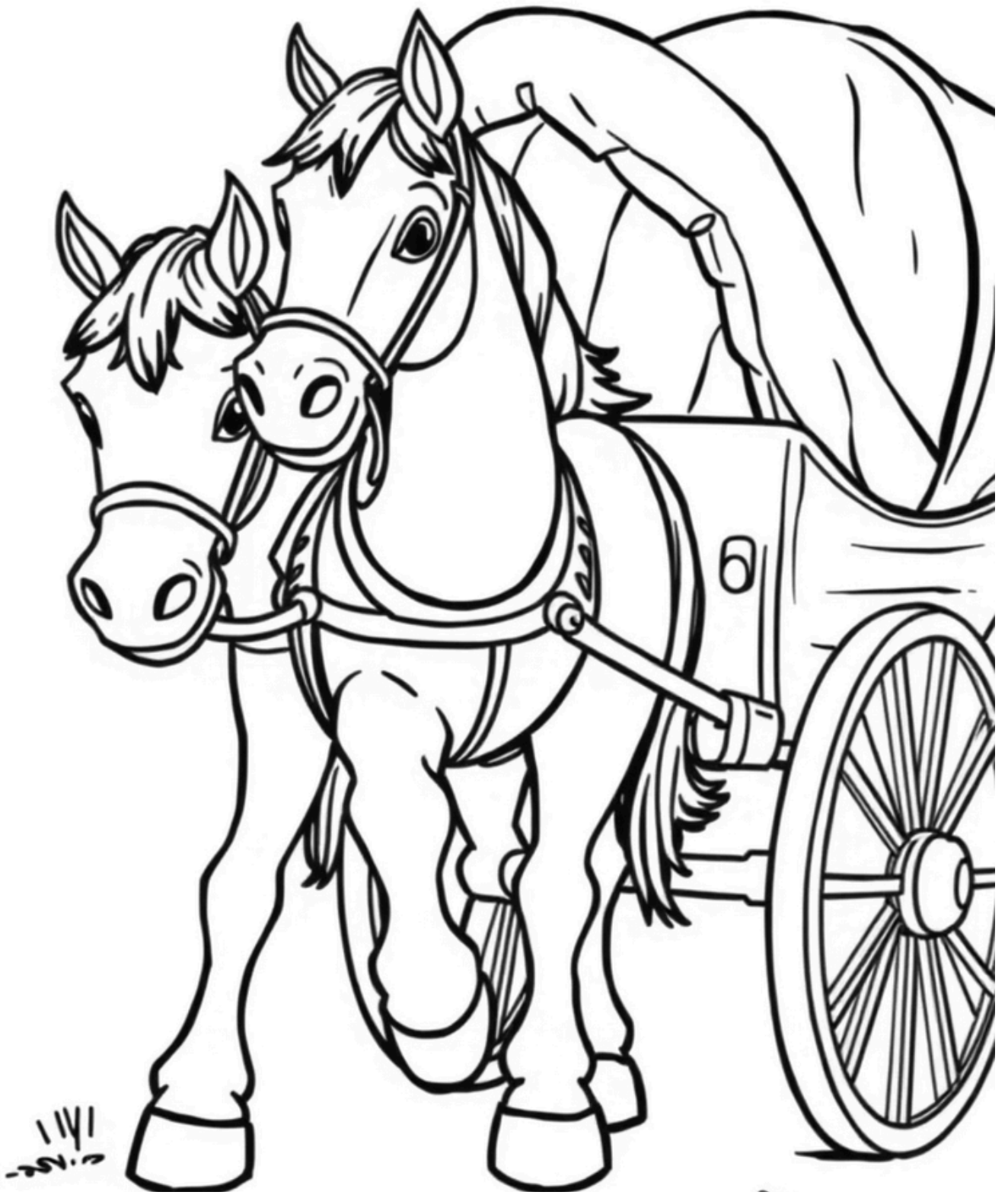

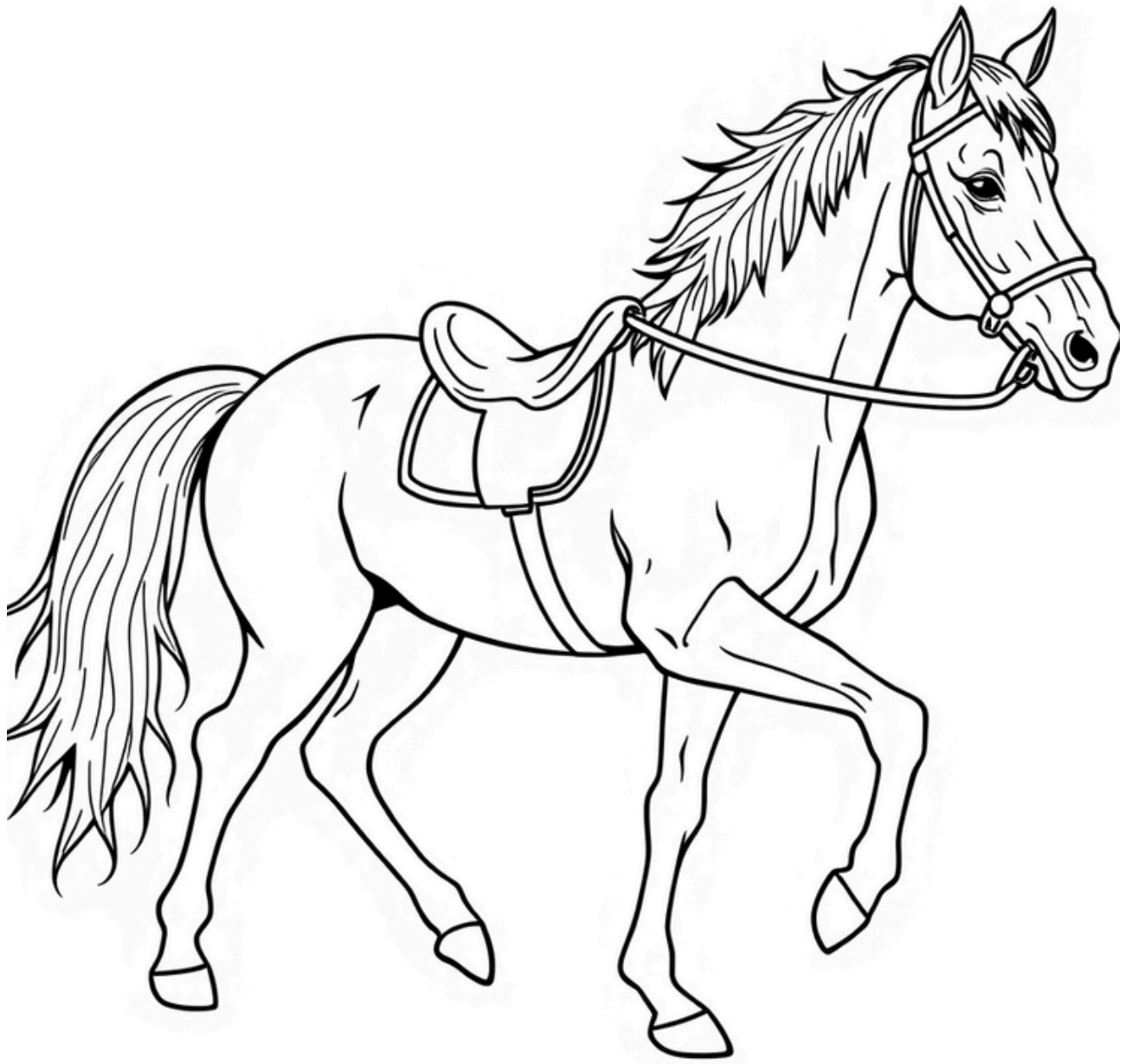

Create your own tea set

Some ideas

- Crown derby
- Minton
- Antoinette
- Royal old albert
- Royal Worcester

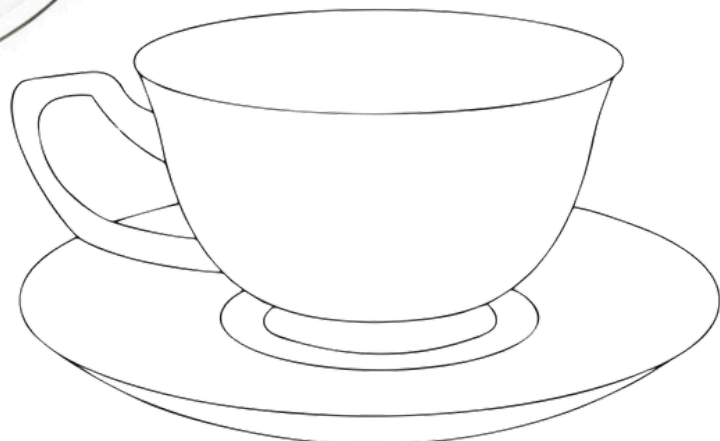
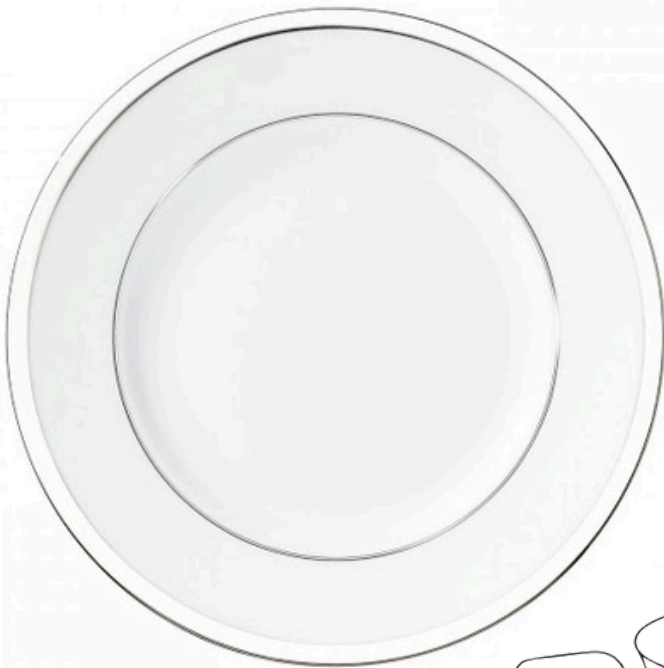

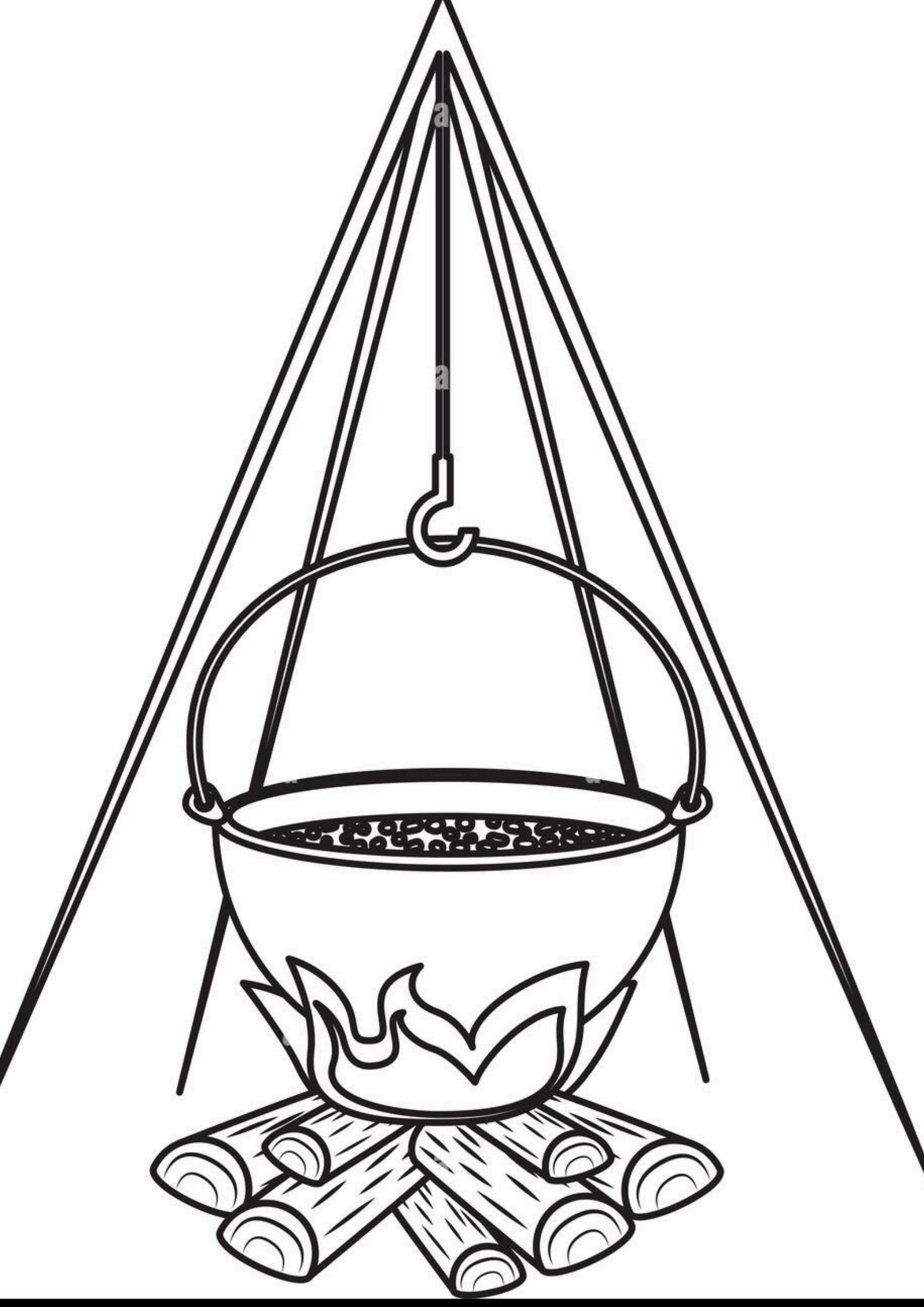

Fill in the missing letters to create words from your list and write them out in full.

Dog Horse Brother Sister Mam
Dad Camp Car Trailer Site

_ i s t e _

_ r o t h _ _

_ a m p

t r _ _ l _ r

c _ r

_ _ _ s e

d a _

_ _ t e

_ a m

d _ g



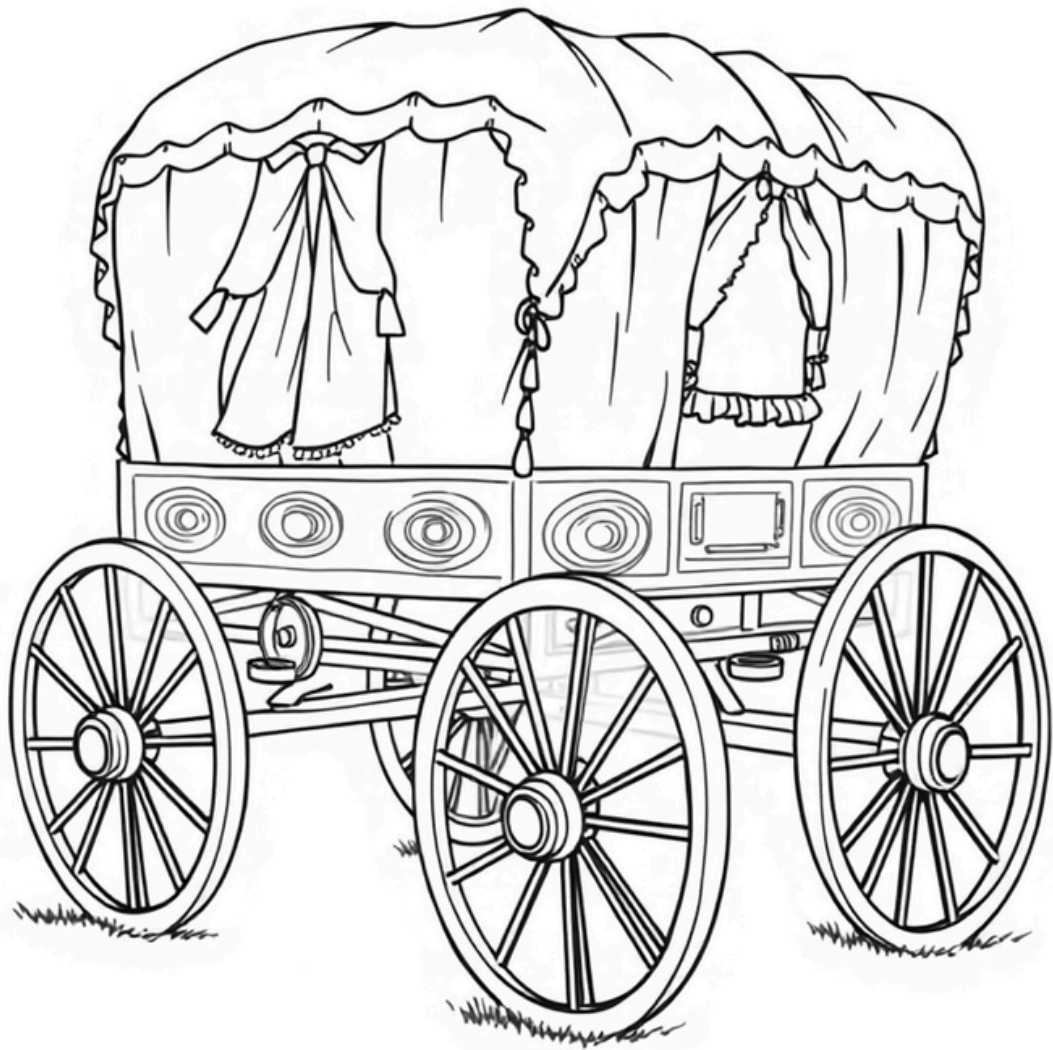



Colour by number

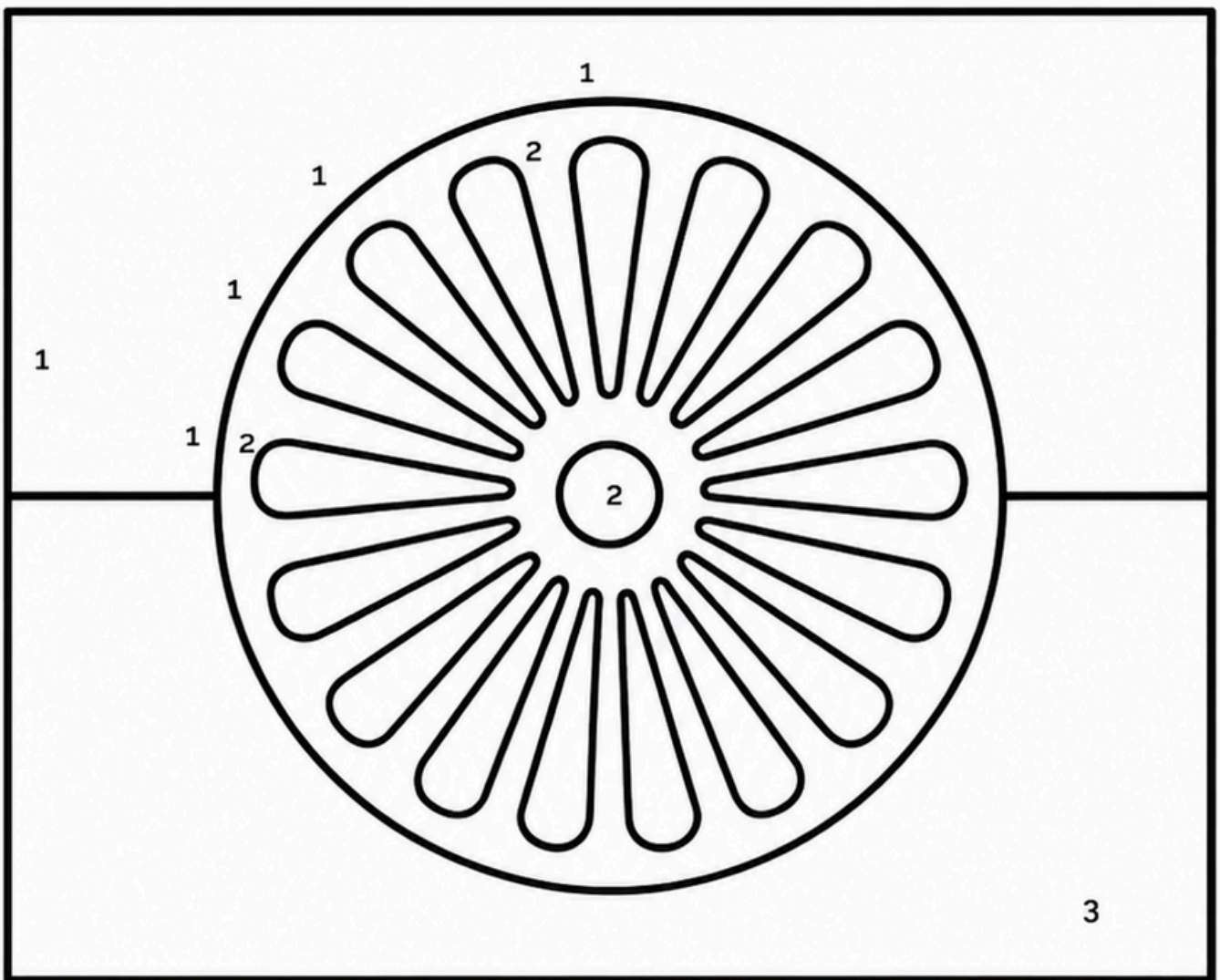

1. **BLUE**

2. **RED**

3. **GREEN**





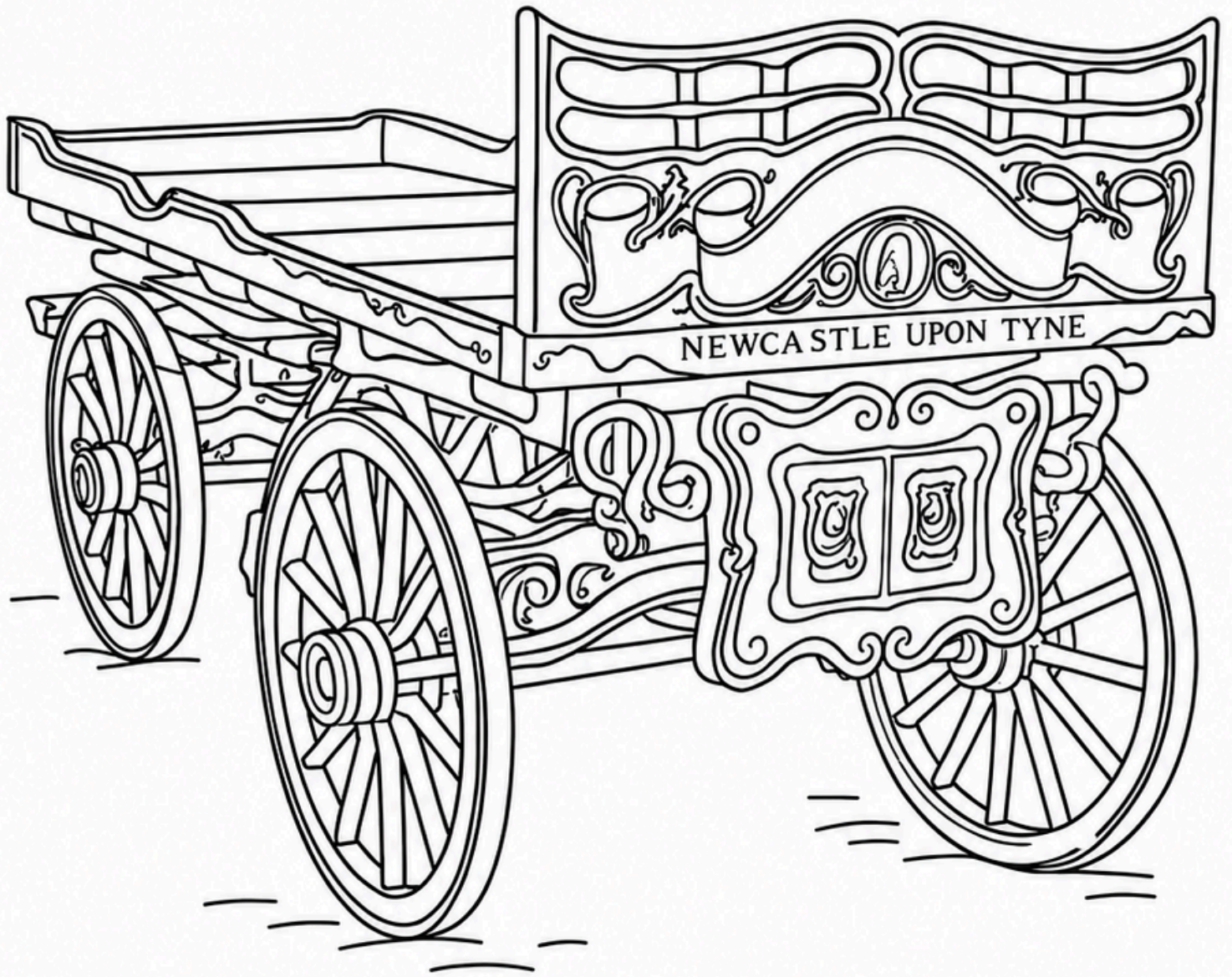

LeedsGATE



@leeds_gate



@LeedsGATE



LEEDSGATE.CO.UK



0113 240 2444

